

Surface damage in ZrB₂-based composite ceramics induced by electro-discharge machining

M. NAKAMURA, I. SHIGEMATSU, K. KANAYAMA, Y. HIRAI
 Government Industrial Research Institute, Nagoya 1-1, Hirate-cho, Kita-ku, Nagoya,
 462 Japan

Electro-conductive ZrB₂-based composite ceramics, containing SiC and B₄C, were machined with an electro-discharge machining (EDM) process. The EDMed surfaces were covered with resolidified ZrB₂ layers. Many open pores and surface cracks were observed on the surfaces. The strength degradation of the ceramics caused by machining was evaluated by three point bending tests of the partially EDMed bending specimens. The effects of pulsed current, pulse duration and duty factor on the strength and the roughness of EDMed surfaces are discussed. The strength of EDMed specimens was increased with decreases in pulse current, pulse duration and duty factor. The roughness of EDMed surfaces was decreased with decreases in pulse current, pulse duration and duty factor. The reliability of the ceramics EDMed with the appropriate conditions was as high as that of the ceramics ground with a 400 grit diamond wheel. It would be possible to use the carefully EDMed ZrB₂-based composite ceramics as structural components without any additional finishing processes.

1. Introduction

Zirconium boride (ZrB₂) ceramics have a high melting point, high hardness, low electrical resistance and excellent corrosion resistance against molten iron and slag [1, 2]. It is one of the promising materials for high temperature applications in the iron industry. However, in manufacturing processes of complex-shaped ZrB₂ ceramic components, grinding by a diamond tool is not efficient and takes great skill.

In order to make complex-shaped hard metal components, electro-discharge machining (EDM) methods have been widely applied. They can be applied to any electro-conductive materials. Recently, machining of some kinds of electro-conductive ceramics with EDM processes has been reported [3–6].

While it is well known that surface damage in ceramics induced by machining decreases the strength of machined ceramics considerably. The evaluation of the surface damage in a structural ceramic component induced by EDM processes is essential [6, 7].

In the present report, ZrB₂-based composite ceramics were machined with an EDM process. The surface damage caused during machining have been studied. The effects of some EDM conditions, such as pulse duration, pulse current and duty factor, on the surface damage of EDMed ceramics were discussed. The damage was evaluated with flexural strength of EDMed specimens measured by three point bending test. Fracture surfaces of bending specimens were observed by scanning electron microscopy (SEM). Furthermore, X-ray diffraction patterns of original body and EDMed surfaces were examined.

2. Experimental procedure

Commercially available ZrB₂-based composite ceramics (Asahi Glass Company) were used as workpieces to be EDMed. Some properties and composition of the ceramic, are shown in Table I. Its excellent oxidation resistance up to 1573 K have been reported [1, 3].

A die sinking EDM machine fitted with a vertically operating servo-controlled head and a square wave pulse generator was used for machining. The open voltage between workpiece and tool electrode was about 100 V. Periodic tool retraction, taking up to about half of the available machining time, was incorporated to assist flushing the machining zone. Dielectric fluid was flushed from a jet beside the machining area. Industrial pure copper (negative polarity) was used as a tool electrode. Pulse current, I_p , pulse duration; τ_p , and pulse interval time, τ_{off} , were measured with a storage oscilloscope using a pulse current transformer during machining. The duty factor, D , was determined according to the following equation:

$$D = \tau_p / (\tau_p + \tau_{off}) \times 100\% \quad (1)$$

Surface profiles of machined workpieces were obtained by Talysurf 4 (Rank Taylor Hobson). The radius of the probe tip for measurement was 2.5 μm .

Evaluation of surface damage was conducted by measuring the flexural strength of EDMed bending specimens. Six specimens of size 3 mm \times 4 mm \times 30 mm were prepared for each EDM condition. Before EDM, all side faces of specimens were ground with a 400 grit resin-bonded diamond wheel. One side

TABLE I Some properties and composition of ZrB_2 -based composite ceramics used as workpieces

| | | |
|--|--------------------|------|
| Density (g/cm^3) | 4.1 | |
| Flexural strength (MPa) | 396 | |
| Vicker's hardness (GPa) | 24.7 | |
| Fracture toughness ($MN m^{-3/2}$) | 4.0 | |
| Young's modulus (GPa) | 459 | |
| Poisson's ratio | 0.15 | |
| Electrical resistivity (Ωcm) | 1×10^{-4} | |
| Composition (wt %) | ZrB_2 | 68.6 |
| | B_4C | 25.2 |
| | SiC | 6.2 |

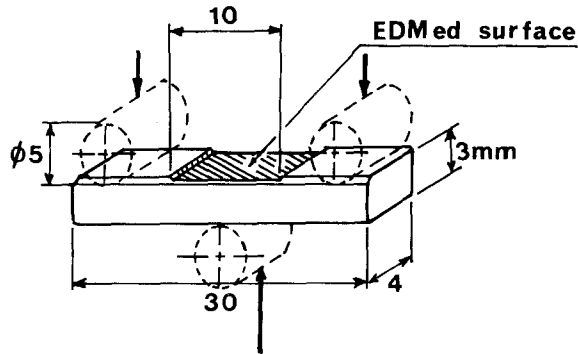

Figure 1 Dimensions of bending specimen.

face of each specimen, was EDMed partially, as shown in Fig. 1. Three point bending tests (the span was 20 mm) were carried out at room temperature.

X-ray diffraction patterns of a polished surface

and EDMed surfaces were obtained by rotating anode type X-ray diffractometer Geigerflex RAD-RB (Rigaku Corporation), using CuK_{α} radiation.

3. Results and discussion

The EDMed surfaces with various conditions are shown in Fig. 2. There were many pores and surface cracks connecting the pores. Those cracks were thought to be propagated during resolidifying and shrinking processes in the surface layers after melting caused by the discharges.

Fig. 3 shows the effects of pulse duration on the flexural strength and the surface roughness. The influence of pulse duration on surface roughness was serious. However, the strength degradation was relatively moderate. Fracture surfaces of bending specimens EDMed with various pulse duration are shown in Fig. 4. When pulse duration was long, the EDMed surface was covered with the thick resolidified layer. In spite of the surface cracks in a resolidified layer, observed in Fig. 2, the thickness of the resolidified layers cannot be related with the degree of strength degradation, directly.

X-ray diffraction patterns of the polished surface and the EDMed surfaces are shown in Fig. 5. Although the EDMed surfaces were covered with the resolidified layers, all of the patterns were almost the same. The resolidified layers covering the EDMed surfaces were mainly ZrB_2 . Increasing in the pulse duration decreased the height of SiC and B_4C peaks in the patterns of EDMed surfaces. Considering that the decomposition temperature of SiC is about 3100 K

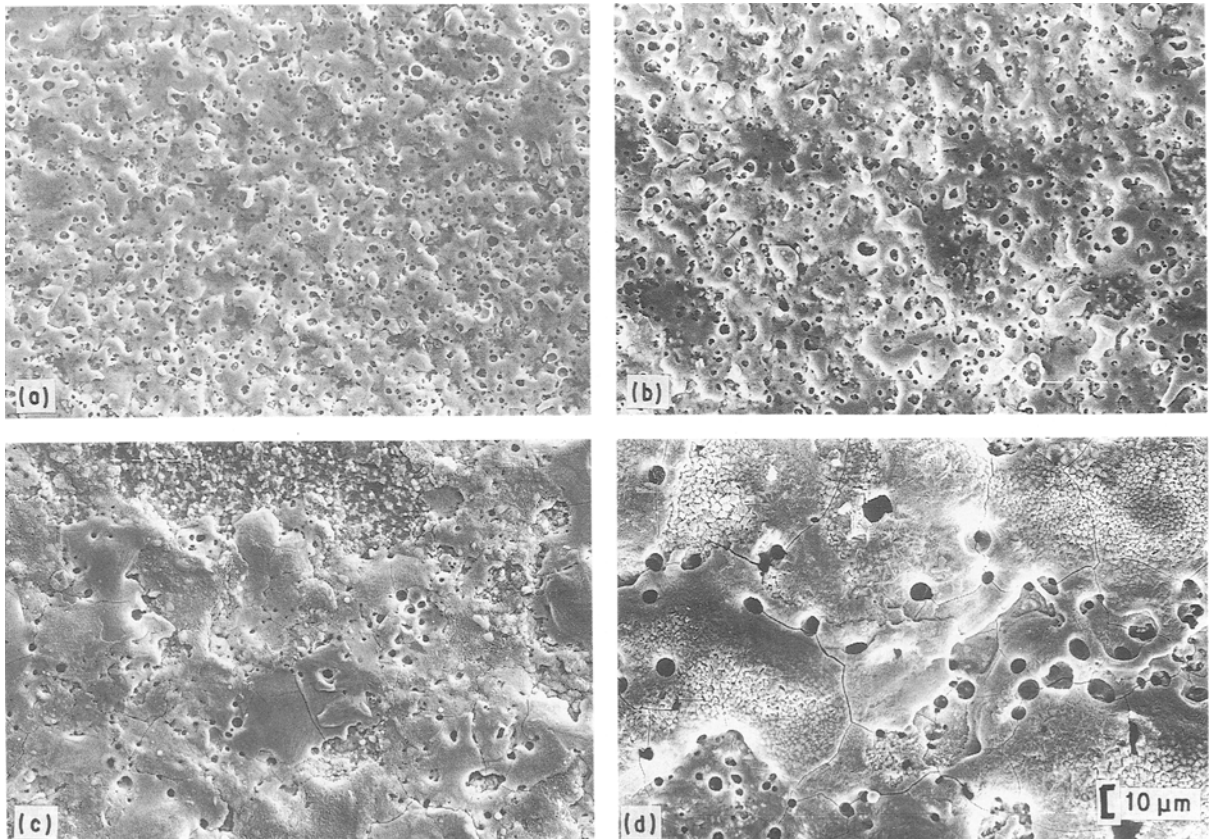

Figure 2 EDMed surfaces at 50% duty factor. (a) $I_p = 1 A$, $\tau_p = 2 \mu s$ (b) $9 A$, $2 \mu s$ (c) $1 A$, $125 \mu s$ (d) $9 A$, $125 \mu s$.

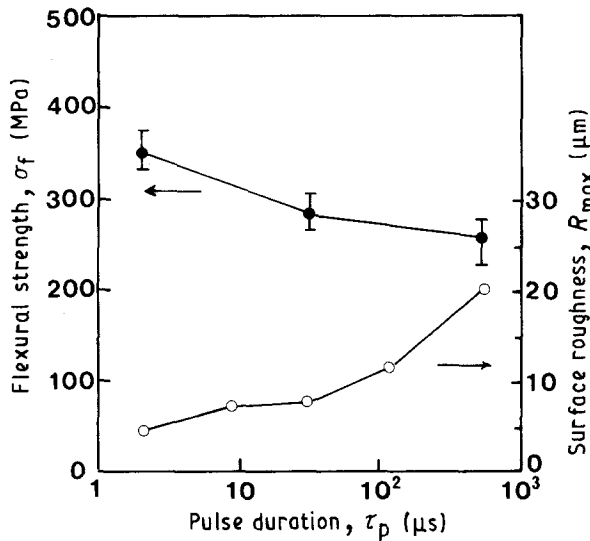

Figure 3 Effects of pulse duration on flexural strength and surface roughness ($I_p = 6$ A, $D = 50\%$).

and the melting point of B_4C is about 2700 K, it was supposed that the SiC and B_4C crystals in the ceramics were decomposed and dissolved in molten ZrB_2 at the melting point of ZrB_2 , which is about 3300 K [8].

Effects of pulse current on the flexural strength and the surface roughness are shown in Fig. 6. Increasing in pulse current decreased the strength and increased the roughness. Fracture surfaces of EDMed bending specimens are shown in Fig. 7. When the large pulse current was applied for machining, the apparent cracks induced by machining could be observed near the surface. Fig. 8 shows the polished cross section of the surface EDMed with large pulse current. The microstructure near the machined surface was not different from that of the base material. Therefore the serious strength degradation was mainly caused by the surface cracks induced by machining.

Effects of duty factor on the strength and the surface roughness are shown in Fig. 9. Both of the pulse current and pulse duration were kept constant. In spite of the stable surface roughness, the increase in the duty factor decreased the strength obviously. The surfaces EDMed with various duty factors were observed by SEM. However, there were not any evi-

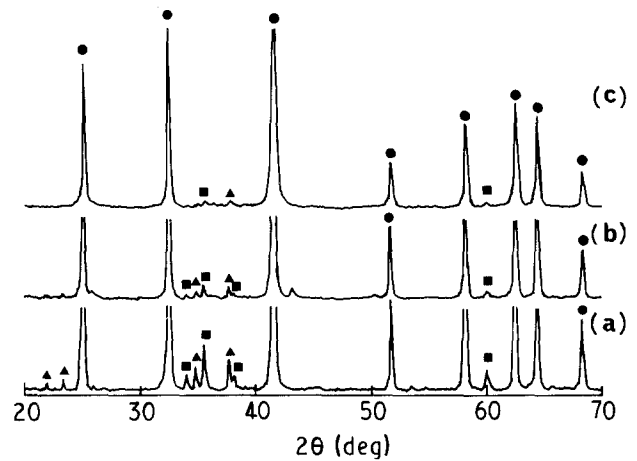

Figure 5 X-ray diffraction patterns for polished surface and EDMed surfaces. (●) ZrB_2 , (■) SiC and (▲) B_4C . (a) Polished surface, (b) EDMed surface ($I_p = 6$ A, $\tau_p = 30$ μ s, $D = 50\%$), (c) EDMed surface ($I_p = 6$ A, $\tau_p = 500$ μ s, $D = 50\%$).

ent differences among them. Therefore it was thought as follows. Pulse interval time of 15 μ s ($D = 66\%$) is long enough for the resolidification process of a small amount of the composite ceramic melted by the individual discharge. Thus the profiles and the roughness of the surfaces EDMed with various duty factors were similar to each other. However, when the duty factor was small, the pulse interval time was so short that the heat given by the individual discharge would not be lost completely in the pulse interval, by the heat transfer to the dielectric fluid and also by heat conduction inside the workpiece. Thus the temperature at the machining surface would increase discharge by discharge. The surface damage was thought to be induced by the large thermal stress due to such a temperature distribution.

As a result, small pulse current, short pulse duration and small duty factor were effective in order to perform the machining of the ceramics without serious strength degradation of the components.

In order to use a EDMed ceramic as a structural component, the reliability of the ceramic is essential. A strength distribution of 18 bending specimens EDMed with an appropriate condition ($I_p = 1$ A, $\tau_p = 2$ μ s,

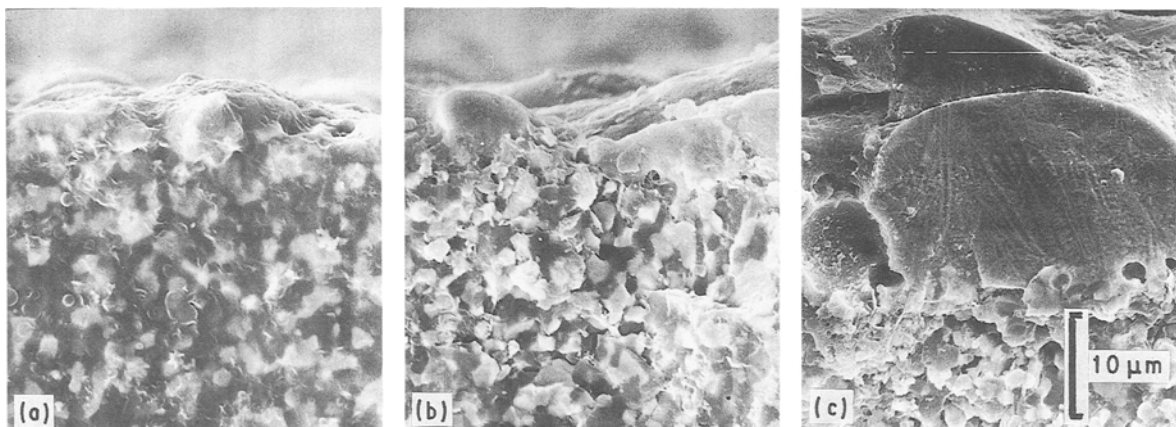

Figure 4 Fracture surfaces of bending specimens EDMed with various pulse durations ($I_p = 6$ A, $D = 50\%$). (a) $\tau_p = 2$ μ s, (b) 30 μ s, (c) 500 μ s.

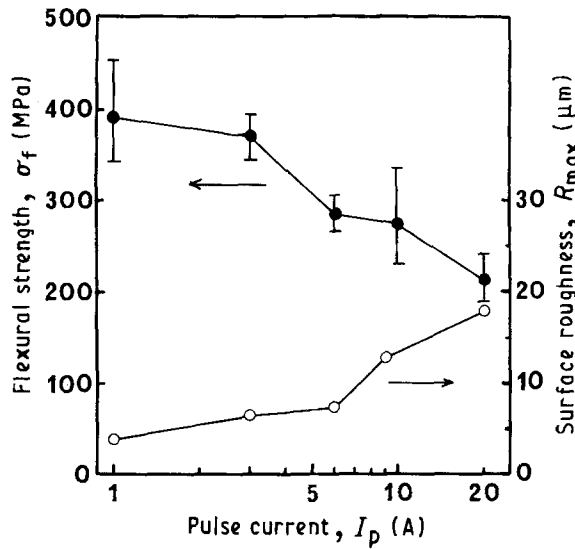

Figure 6 Effects of pulse current on flexural strength and surface roughness ($\tau_p = 30 \mu\text{s}$, $D = 50\%$).

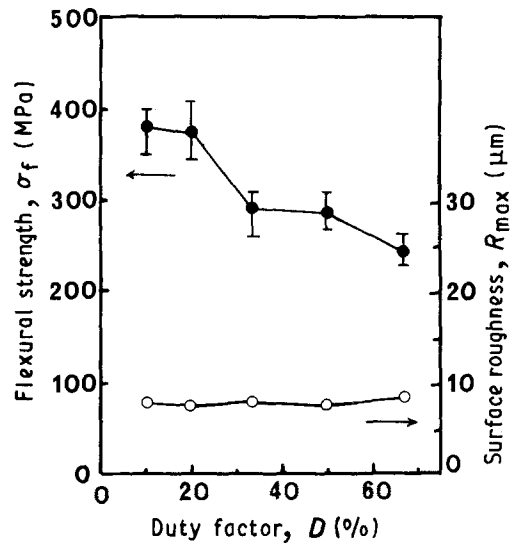

Figure 9 Effects of duty factor on flexural strength and surface roughness ($I_p = 6 \text{ A}$, $\tau_p = 30 \mu\text{s}$).

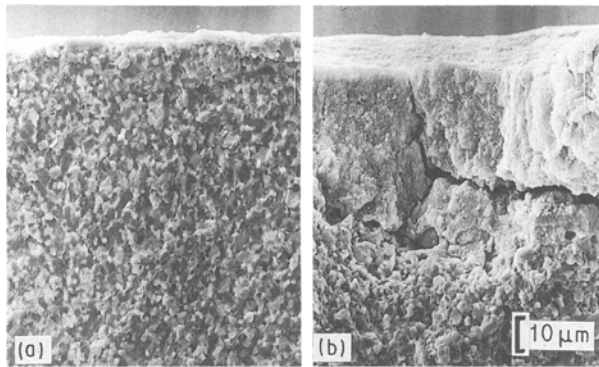

Figure 7 Influence of pulse current on fracture surfaces of EDMed bending specimens ($\tau_p = 30 \mu\text{s}$, $D = 50\%$). I_p : (a) 1 A, (b) 10 A.

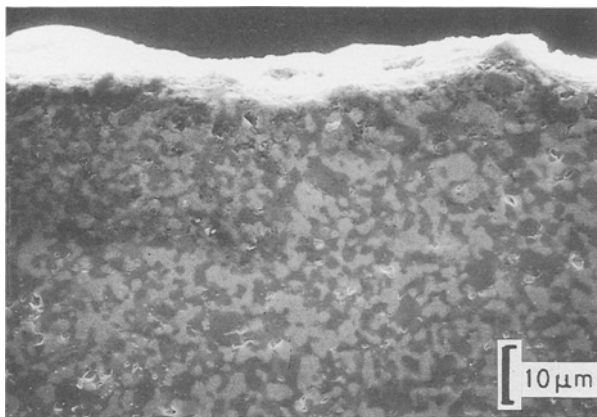

Figure 8 Polished cross section of EDMed surface ($I_p = 10 \text{ A}$, $\tau_p = 30 \mu\text{s}$, $D = 50\%$).

$D = 10\%$) and that of 20 specimens ground with a 400 grit diamond wheel are shown in Fig. 10. The average flexural strength and the Weibull modulus for the strength distribution of the EDMed specimens were similar to those of the ground specimens. The highest flexural strength of the EDMed specimen

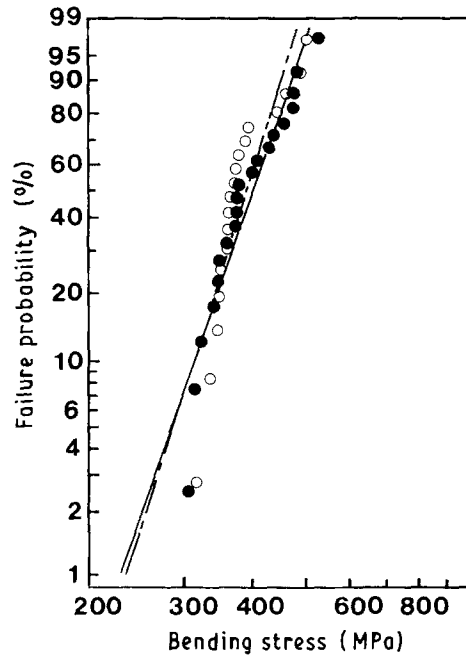

Figure 10 Strength distributions of EDMed specimens and ground specimens. (○ - -) EDMed specimens/average flexural strength: 385 MPa, Weibull modulus: 8.2; (● - -) ground specimens/average flexural strength: 396 MPa, Weibull modulus: 7.5.

attained was 503 MPa. It would be possible to use the ZrB_2 -based composite ceramics EDMed with appropriate conditions as structural components without any additional finishing processes.

4. Conclusions

1. The strength of EDMed ZrB_2 -based composite ceramic components was increased with decreases in pulse duration, pulse current and duty factor.
2. The surfaces of the EDMed ceramics were covered with resolidified ZrB_2 layers. The thickness of the layer was increased with the increase in pulse duration.

3. It would be possible to use the ZrB_2 -based composite ceramics EDMed with the appropriate conditions as structural components without any additional finishing processes. The highest flexural strength of the EDMed specimen attained was 503 MPa. The Weibull modulus for the strength distribution was about 8.2.

Acknowledgements

The authors would like to express their gratitude to Dr Toshio Ishizuka of their institute for the chemical analysis of composition of the original ZrB_2 -based composite ceramic. Thanks are also due to Mr Michihide Machida of their institute for the X-ray diffraction analyses of original and EDMed ZrB_2 -based composite ceramics.

References

1. M. OKUMIYA and Y. AMAMIYA, *Fine Ceramics* **5** (1984) 108.
2. A. L. WAYDA, L. F. SCHNEEMEYER and R. L. OPILA, *Appl. Phys. Lett.* **53** (1988) 361.
3. K. MANNAMI, K. SAKAI and M. OKUMIYA, *J. Ceram. Soc. Japan* **92** (1984) 648.
4. M. RAMULU, *Advanced Ceramic Materials* (4) (1988) 324.
5. NANCY F. PETROFES and AHMED M. GADALLA, *Ceramic Bulletin* **67**(6) (1988) 1048.
6. M. NAKAMURA, K. KANAYAMA and Y. HIRAI, *Materials and Manufacturing Processes* **4**(3) (1989) 425.
7. M. NAKAMURA, K. KANAYAMA, Y. HIRAI, S. ITO and K. KUBO, Proceedings of the International Symposium for Electro-Machining (ISEM-9) (Nagoya, Japan, April 1989) p. 271.
8. M. GRAYSON *et al.*, "Encyclopedia of chemical technology" (Wiley-Interscience, Canada, 1978) pp. 126 and 521.

Received 3 July 1990

and accepted 31 January 1991